

MIGATRONIC

OPERATOR

Auto Darkening Welding Helmet Owner's Manual

* Designed to be used with Operator M-G1 PAPR blower unit



SAFETY WARNINGS - READ BEFORE USING



WARNING

Read & Understand All Instructions Before Using



Auto-Darkening welding helmets are designed to protect the eye and face from sparks, spatter and harmful radiation under normal welding conditions. This auto darkening filter will automatically turn on when pick it up. The filter automatically changes from a light state to a dark state when an arc is struck, and it returns to the light state when welding stops.

The Auto-Darkening welding helmet comes assembled. But before it can be used, it must be adjusted to fit the user properly. Check battery surfaces and contacts and clean it if necessary. Verify if the battery is in good condition and installed properly. Set up for delay time, sensitivity and shade number for your application. Before welding, please make sure the ADF was set to WELDING / CUTTING mode instead of GRIND mode.

The helmet should be stored in dry, cool and dark area and remove the battery, when not using it for a long time.



WARNING



- Employees and students shall make a visual inspection of their protector prior to each use. Protectors which exhibit broken parts, distortion, or excessive scratches on the lens, are unsuitable for use and shall not be worn.
- The protection marked in accordance with this standard is only provided when all lens and retention components are installed according to the list or other manufacturer's instructions.
- Eye and face protectors that have been subject to an impact shall not be used and shall be discarded and replaced.
- This Auto-Darkening welding helmet is not suitable for laser welding.
- Never place this helmet and Auto-Darkening filter on a hot surface.
- Never open or tamper with the Auto-Darkening filter.
- This Auto-Darkening welding helmet will not protect against severe impact hazards.
- This helmet will not protect against explosive devices or corrosive liquids.
- Do not make any modifications to either the filter or helmet, unless specified in this manual. Do not use replacement parts other than those specified in this manual. Unauthorized modifications and replacement parts will void the warranty and expose the operator to the risk of personal injury.
- Should this helmet not darken upon striking an arc, stop welding immediately and contact your supervisor or your dealer.
- Do not immerse the filter in water.
- Do not use any solvents on the filter screen or helmet components.
- Use only at temperatures: $-5^{\circ}\text{C} \sim +55^{\circ}\text{C}$ ($23^{\circ}\text{F} \sim 131^{\circ}\text{F}$).
- Storing temperature: $-20^{\circ}\text{C} \sim +70^{\circ}\text{C}$ ($-4^{\circ}\text{F} \sim 158^{\circ}\text{F}$). The helmet should be stored in dry cool and dark area, when not using it for a long time.
- Protect filter from contact with liquid and dirt.
- Clean the filter surface regularly; do not use strong cleaning solutions. Always keep the sensors and solar cells clean using a clean lint-free tissue.
- Regularly replace the cracked / scratched / pitted front cover lens.
- The ADF shall only be used in conjunction with the inner cover lens.
- Toughened mineral filter oculars shall only be used in conjunction with a suitable backing ocular.
- If the symbols are not common to both the ocular and the frame then it is the lower level which shall be assigned to the complete eye-protector.

- We recommend a use for a period of 5 years. The duration of use depends on various factors such as use, cleaning storage and maintenance. Frequently inspections and replacement if it is damaged are recommended.
- The product is in conformity with Directive 2001/95/EC, Regulation (EU) 2016/425, Annex II.
- The user shall contact the health and safety representative to ensure he is given the proper protection by the personal eyewear during working conditions.



WARNING



Severe personal injury could occur if the user fails to follow the above mentioned warnings and/or fails to follow the operating instructions.

COMMON PROBLEMS AND REMEDIES

• Irregular Darkening Dimming

Headgear has been set unevenly and there is an uneven distance from the eyes to the filter lens (Reset the headgear to reduce the difference to the filter).

• Auto-Darkening filter does not darken or flickers

- ① Front cover lens is soiled or damaged (Change the cover lens).
- ② Sensors are soiled (Clean the sensors surface).
- ③ Welding current is too low (Reset the sensitivity level to higher).
- ④ Check battery and verify they are in good condition and installed properly. Also, check battery surfaces and contacts and clean if necessary. Please refer to the "BATTERY INSTALLATION" on page 2.

• Slow response

Operating temperature is too low (Do not use at temperatures below -5 °C or 23 °F).

• Poor vision

- ① Front / inside cover lens and / or the filter is soiled (Change lens).
- ② There is insufficient ambient light.
- ③ Shade number is incorrectly set (Reset the shade number).
- ④ Check if removing the film on the front cover lens.

• Welding helmet slips

Headgear is not properly adjusted (Readjust the headgear).



WARNING



The user must stop using the auto-darkening welding helmet immediately if the above-mentioned problems cannot be corrected. Contact the dealer.

INSTRUCTIONS FOR USE

WARNING! Before using the helmet for welding, ensure that you have read and understood the safety instructions.

• BATTERY INSTALLATION

Slide the battery holder out of the auto darkening filter, (remove the used battery when replacing battery), put new CR2450 batteries inside the battery holder, and put the battery holder back into the auto darkening filter. Please make sure the anode and cathode of the battery are installed correctly (See fig.1).

• POWER ON / OFF

To activate the display screen, press any button. The auto-darkening filter will automatically turn off after a period of inactivity.

• DIGITAL SCREEN ACTIVATION

Press any of four button to activate the digital screen (See fig.2a). After 15 seconds, digital screen will automatically turn to standby mode. Short press the button again will activate the screen once more and previous settings will remain.

• MODE CONTROL

Short Press "ON / MODE" button to select the mode appropriate for the work activity (See fig.2a):

Weld Mode – used for most welding applications. Push "FUNC" button to adjust shade number, sensitivity, and delay settings properly before welding. In this mode the lens turns to dark immediately when you start welding.

Cut Mode – used for cutting applications. Push "FUNC" button to adjust shade number, sensitivity, and delay settings properly before cutting. In this mode the lens shade turns to dark immediately when you start cutting.

Grind Mode – used for grinding applications. In this mode the lens shade is fixed shade No. 3. Can not adjust shade number, sensitivity, and delay settings.

External Grind Button Use – The user can also switch to the grind mode using the external grinding switch button (which is located on the top-right of the helmet during wear) (See fig.1b), by long-pressing the "GRIND" button for 2 seconds. Long pressing the "GRIND" button for 2 second again, it will return to the previous mode. Please switch back to WELD/CUT mode after use for battery save.

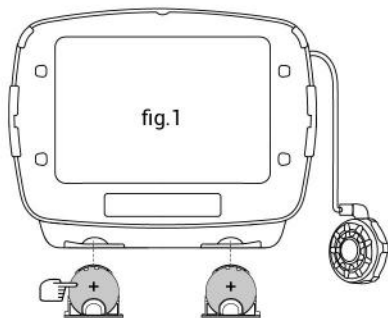

Be sure Positive (+) side of battery faces up.

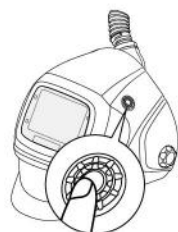

fig.1b

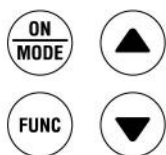

fig.2a

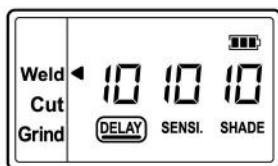

fig.2b



fig.2c

• BATTERY INDICATOR

The symbol "■■■■" show the current state of the battery (See fig.2b). The volume of batteries has four levels symbol to appear (See fig.2c). The symbol "□" appears on the display screen before 1-2 days of battery life remains, the CR2450 lithium batteries should be replaced in time. The symbol of the Battery Indicator is not real-time, should be updated after pressing "ON / MODE" button shortly.

• VARIABLE SHADE CONTROL

After turn on the lens, short press "FUNC" button to choose "SHADE", and adjust the lens shade number. Use "▲" and "▼" buttons to select the lens shade in the dark state. The shade range for each mode are as follows:

Cut Mode – Shade 5 ~ 8 (See fig.3a) **Weld Mode** – Shade 9 ~ 13 (See fig.3b)

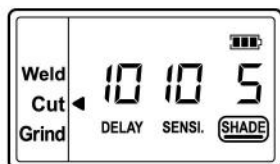

fig.3a

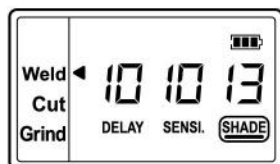

fig.3b

Grind Mode – No. 3 only (See fig.3c). Flip up the front-flip part for grinding job, the auto darkening filter also has grind mode setting.

Select the proper shade number for your welding / cutting process, by referring to the “Shade Guide Table” on the last page.

• SENSITIVITY CONTROL

Press “FUNC” button to choose “SENSITIVITY”. Use “▲” and “▼” buttons to make the lens more or less sensitive to arc light of different welding processes. Sensitivity setting 5-10 is the normal setting for everyday use. The sensitivity ranges for each mode are as follows:

Cut Mode (Shade 5 ~ 8) / **Weld Mode** (Shade 9 ~ 13) – Sensitivity 0 ~ 10 (See fig.4a / 4b)

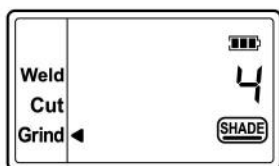

fig.3c

Grind Mode – No sensitivity adjustment

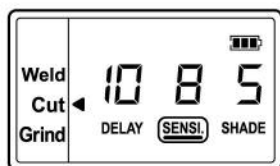

fig.4a

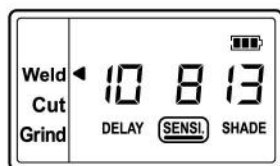

fig.4b

As a simple rule for optimum performance, it is recommended to set sensitivity to the maximum at the beginning and then gradually reduce it, until the filter reacts only to the welding light flash and without annoying spurious triggering due to ambient light conditions (direct sun, intensive artificial light, neighbouring welder's arcs etc.).

It may be necessary to adjust helmet sensitivity to accommodate different lighting conditions or if lens is flashing On and Off. Adjust helmet sensitivity as follows: Adjust helmet sensitivity in lighting conditions helmet will be used in.

- Press “▼” button to lower setting to 0.
- Face the helmet in the direction of use, exposing it to the surrounding light conditions.
- Press “▲” button repeatedly until the lens darkens, then press “▼” button until lens clears. Helmet is ready for use. Slight readjustment may be necessary for certain applications or if lens is flashing on and off.

• DELAY CONTROL

Press "FUNC" button to choose "DELAY", begin lens delay adjustments. Use the Lens Delay Control "▲" and "▼" buttons to adjust the time for the lens to switch to the clear state after welding or cutting.

Cut Mode (Shade 5 ~ 8) / **Weld Mode** (Shade 9 ~ 13) – Delay 0 ~ 10 (See fig.5a / 5b)

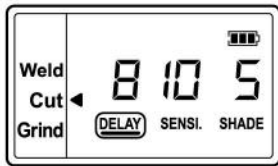

fig.5a

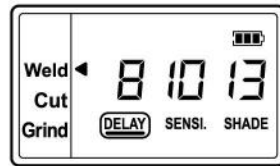

fig.5b

Grind Mode – No sensitivity adjustment

The delay is particularly useful in eliminating bright after-rays present in higher amperage applications where the molten puddle remains bright momentarily after welding. Use the Lens Delay Control buttons to adjust delay from 0 to 10 (0.1 to 1.0 second). When welding stopped, the viewing window automatically changes from dark back to light but with a pre-set delay to compensate for any bright afterglow on the workpiece. The delay time / response can be set from Level 0 to level 10. It is recommended to use a shorter delay with spot welding applications and a longer delay with applications using higher currents. Longer delays can also be used for low current TIG welding, and TIG / MIG / MAG pulse.

• ADJUSTING THE FIT OF THE HELMET

The overall circumference of the headband can be made larger or smaller by rotating the knob on the back of the headband (See adjustment "Y" in fig.6). This can be done while wearing the helmet and allows just the right tension to be set to keep the helmet firmly on the head without it being too tight.

- If the headband is riding too high or too low on your head, adjust the strap which passes over the top of your head. To do this release the end of the band by pushing the locking pin out of the hole in the band. Slide the two portions of the band to a greater or lesser width as required and push the locking pin through the nearest hole (See adjustment "W" in fig.6).
- Front and back bands will automatically self-adjust according to headform, and soft pads suit forehead and back of head perfectly, which will bring more comfort (See fig.7a). Test the fit of the headband by lifting up and closing down the helmet a few times while wearing it. If the headband moves while tilting, re-adjust it until it is stable.

• ADJUSTING THE DISTANCE BETWEEN THE HELMET AND THE FACE

Step 1: Press down and hold the "LOCK" latch on both sides (See fig.7b) and it can be slide back and forth.

Step 2: Loosen the "LOCK" latch and keep it snap into slots. Please make sure the distance between the lens to both eyes are equal, to avoid uneven darkness.

• ADJUSTING VIEW ANGLE POSITION

Tilt adjustment is located on right side of helmet. Loosen the right headgear tension knob and adjust the lever forward or back to the proper position. Re-tighten the right headgear tension knob (See fig.7c).

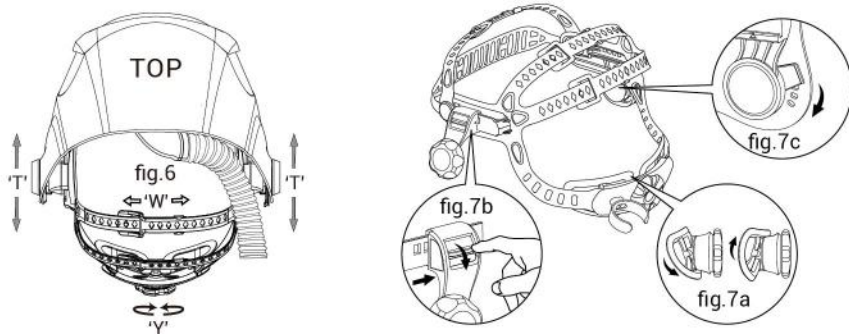

• MARKING

The shell and the auto darkening filter are marked accordingly. Classification for eye and face protection is following EN ISO 16321-1:2022, EN ISO 16321-2:2021, EN175, EN166.

MIGATRONIC Auto darkening filter 750MG

16321 MG W 3 / 5-8/9-13 V1

Number of this standard	16321	MG	W	3	/	5-8/9-13	V1
Manufacturer's identification							
Filtering performance code letter							
Light shade							
Dark shade range							
Angle dependence of luminous transmittance							

Marking on helmet:

"MG EN 175 B" : MG: manufacturer's identification
EN 175: number of this standard
B: resistance to medium energy impact

Marking on front cover lens:

"MG 1 B" : MG: manufacturer's identification
1: optical class
B: resistance to medium energy impact

Marking on inside cover lens:

"MG 1 B" : MG: manufacturer's identification
1: optical class
B: resistance to medium energy impact

Marking on side lens:

"5 MG 1 B CE" : 5: dark state
MG : manufacturer's identification
1: optical class
B: resistance to medium energy impact



CE Mark / PPE Regulation 2016/425
Notified Body: 2834
CCQS Certification Services
Block 1 Blanchardstown
Corporate Park,
Ballycoolin Road, Blanchardstown,
Dublin15, D15 AKK1, Ireland.

DIN CERTCO Gesellschaft fuer
Konformitaetsbewertung mbH
Alboinstrasse 56
12103 Berlin
Germany

Notified body number 0196

MAINTENANCE

• REPLACING THE FRONT LENS HOLDER

Disassembling: Remove the front lens holder per fig.8a / 8b.

Assembling: Fit the one side into slot, then press and lock the other side (See fig.8c).

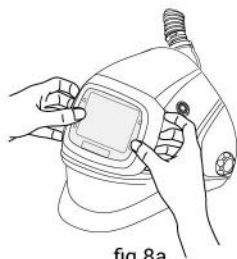

fig.8a

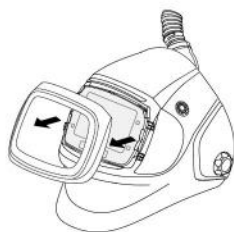

fig.8b



fig.8c

• REPLACING THE AUTO DARKENING FILTER

Disassembling: Hold the helmet so that the inner side is facing towards you. Grasp the wire connector end of the auto-darkening filter (which is connected to the external grinding button), and gently pull it out of the circular socket (See fig.9a). Press the thumb on the bottom sides of the auto darkening filter and push it upward (See fig.9b), remove the filter from the helmet shell (See fig.9c).

Assembling: First insert the auto darkening filter into the slots on left and right sides. Then push the filter down till the locks click (See fig.9d). Take the wire connector end of the auto-darkening filter and make sure to insert it firmly into the external grinding button socket (See fig.9e).

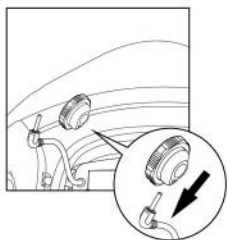

fig.9a

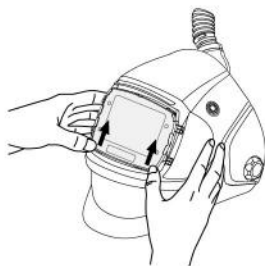

fig.9b

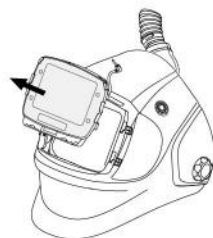

fig.9c

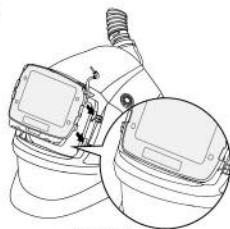

fig.9d

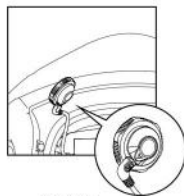

fig.9e

• REPLACING THE OUTSIDE COVER LENS

Replace the outside cover lens if it is damaged.

Disassembling: Remove the front lens holder per fig.8a / 8b. Place your fingernail in recess above filter view window and flex lens upwards until it releases from edges of filter view window (See fig.10a).

Assembling: Install with one side into the slot, then insert the other side.

• **REPLACING THE INSIDE COVER LENS**

Replace the inside cover lens if it is damaged.

Disassembling: Place your fingernail in recess above filter view window and flex lens upwards until it releases from edges of filter view window (See fig.10b).

Assembling: Assemble inside cover lens the same way as it was removed.



fig.10a



fig.10b

• **REPLACING THE FACE SEAL**

The face seal can be used to facilitate cleaning after disassembling from the shell, but it must be replaced if it is damaged.

Press the "LOCK" key on cantilevered components and push the headgear in the direction of arrow to separate headgear from the helmet (See fig.11a). In accordance with the order of A-D in the figure, align the face seal with the velcro inside the helmet shell and make sure the face seal is closely attached to helmet shell (See fig.11b). Then press the "LOCK" key on cantilevered components to install the headgear to the helmet (See fig.11c), buckle up the face seal according to 1-7 points (See fig.11d).

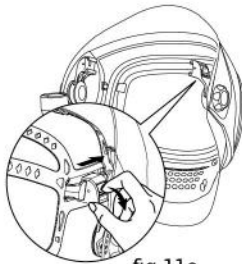

fig.11a

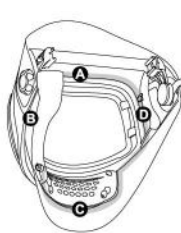

fig.11b

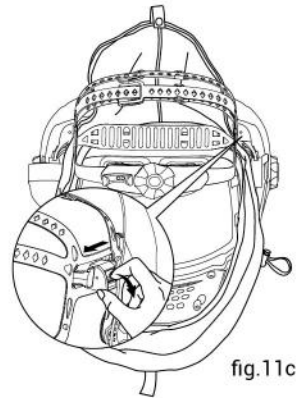
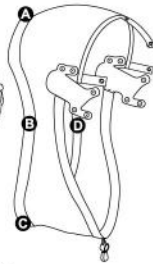

fig.11c

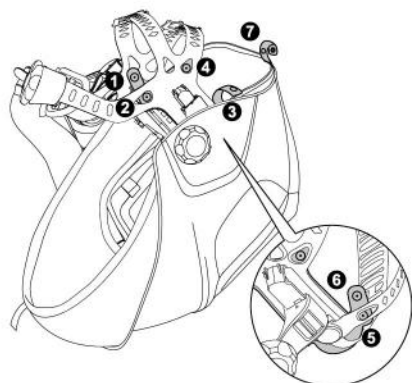
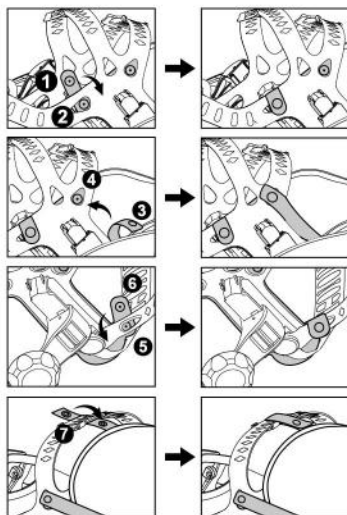

fig.11d



• CLEANING

Clean helmet by wiping with a soft cloth. Use mild disinfection solution to disinfect the protector. Clean the filter surfaces regularly. Do not use strong cleaning solutions. Clean sensors and solar cells with methylated spirit and a clean cloth and wipe dry with a lint-free cloth.

• MAINTENANCE

1. Clean the filter and protection plates by a lens tissue or a clean, soft cloth with proper glass detergent.
2. Use neutral detergent to clean the welding shell and headband.
3. Replace outer and inner protection plates periodically.
4. Don't immerse the lens in water or any other liquid. Never use abrasives, solvents or oil-based cleaners.
5. Don't remove the auto-darkening filter from the helmet. Never try to open the filter.
6. This protector is appropriate for the head form 1-M.
7. Protectors that have been subject to impact shall not be used and shall be discarded and replaced.
8. If the impact level symbols are not equal on both the lens/filter and the frame, then it is the lower level that shall be assigned to the complete protector.
9. The protections corresponding to the code numbers/letter 7, 9, CH are provided by the complete protector only if the respective symbols are equal on both the lens and the frame.
10. Not suitable for driving and road use.
11. A visual inspection is necessary before each use.

TECHNICAL SPECIFICATIONS

Model No.: 750MG

Optical Class:	1 / 1 / 1 / 1
Viewing Area:	107 x 75 mm (4.21" x 2.95")
Cartridge Size:	156 x 123 x 33 mm (6.14" x 4.84" x 1.30")
Arc Sensor:	4
Light State:	DIN 3
Grind State:	DIN 3
Cutting Shade:	Shade No. from 5 to 8
Welding Shade:	Shade No. from 9 to 13
Shade Control:	Internal, Digital Display Control
Power On / Off:	Automatic On / Off
Sensitivity Control:	Low ~ High, Digital Display Control
UV / IR Protection:	Up to Shade DIN13 at all times
Power Supply:	Solar cell. Battery replaceable, 2 x CR2450 lithium battery
Switching Time:	1/25,000 s. from Light to Dark at 55 °C (131 °F)
Grinding:	Yes
Delay (Dark to Light):	0.1 ~ 1.0 s, Digital Display Control
Low Amperage TIG Rated:	≥ 2 amps (DC); ≥ 2 amps (AC)
Operating Temp.:	-5 °C ~ +55 °C (23 °F ~ 131 °F)
Storing Temp.:	-20 °C ~ +70 °C (- 4 °F ~ 158 °F)
Helmet Material:	High Impact Resistance Nylon
Total Weight:	778 g
Application Range:	Stick Welding (SMAW); TIG DC&AC; TIG Pulse DC; TIG Pulse AC; MIG/MAG/CO2; MIG/MAG Pulse; Plasma Arc Cutting (PAC); Plasma Arc Welding (PAW); Air Carbon Arc Cutting (CAC-A); Oxyfuel Gas Welding (OFW); Oxygen Cutting (OC); Grinding
Approved:	CE, EN ISO 16321-1:2022, EN ISO 16321-2:2021, EN 175, EN 166 ANSI Z87.1, Z94.3, AS/NZS 1338.1

PARTS LIST & ASSEMBLY

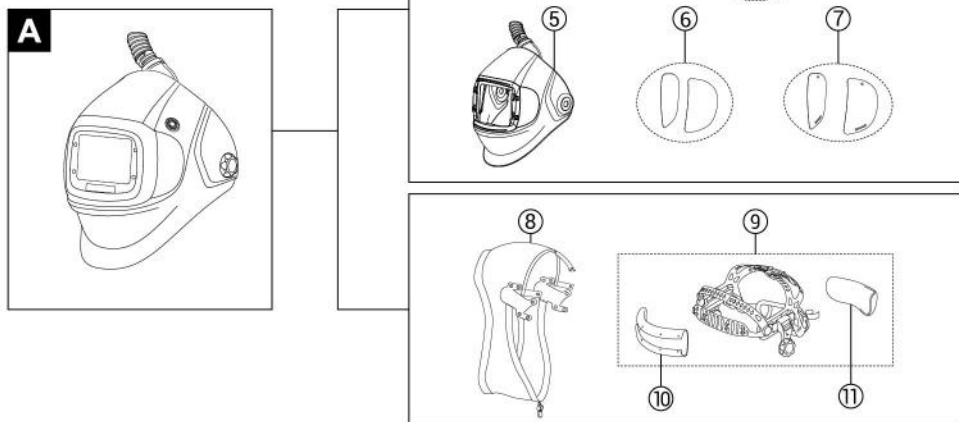

Part List

ITEM	PART NO.	DESCRIPTION
A-1	82901401	Operator Helmet Front Lens Frame
A-2 *	82901101	Operator Helmet Front Cover Lens (160.36x107.3x1.2 mm)
	82901102	Operator Helmet Front Cover Lens (HD) (160.36x107.3x1.2 mm)
	82901103	Operator Helmet Front Cover Lens (anti-scratch) (160.36x107.3x1.2 mm)
A-3	82901301	Operator Helmet Auto Darkening Filter (750MG)
A-4	82901104	Operator Helmet Inside Cover Lens (107x80x1.0 mm)
A-5	82901502	Operator Helmet Shell with Air Duct (air-fed)
A-6	82901403	Operator Helmet Side Lens
A-7	82901402	Operator Helmet Side Lens Cover
A-8	82901507	Operator Helmet Face seal
A-9	82901504	Operator Helmet Headgear (air-fed)
A-10	82901505	Operator Helmet Sweatband
A-11	82901506	Operator Helmet Soft Pad Rear Sweatband

Options with * are for reference only; please check the actual product set for accurate information.

SHADE GUIDE TABLE

GUIDE FOR SHADE NUMBERS

OPERATION	ELECTRODE SIZE 1/32 in. (mm)	ARC CURRENT(A)	MINIMUM PROTECTIVW SHADE	SUGGRSTED ⁽¹⁾ SHADE NO. (COMFORT)
Shielded metal arc welding	Less than 3 (2.5)	Less than 60	7	—
	3-5 (2.5-4)	60-160	8	10
	5-8 (4-6.4)	160-250	10	12
	More than 8 (6.4)	250-550	11	14
Gas metal arc welding and flux cored arc welding		Less than 60	7	—
		60-160	10	11
		160-250 250-500	10 10	12 14
Gas tungsten arc welding		Less than 50	8	10
		50-150	8	12
		150-500	10	14
Air carbon Arc cutting	(Light)	Less than 500	10	12
	(Heavy)	500-1000	11	14
Plasma arc welding		Less than 20	6	6 to 8
		20-100	8	10
		100-400	10	12
		400-800	11	14
Plasma arc cutting	(Light) ⁽²⁾	Less than 300	8	8
	(Medium) ⁽²⁾	300-400	9	12
	(Heavy) ⁽²⁾	400-800	10	14
Torch brazing		—	—	3 to 4
Torch soldering		—	—	2
Carbon arc welding		—	—	14
PLATE THICKNESS				
	in.	mm		
Gas welding	Under 1/8	Under 3.2		4 or 5
	1/8 to 1/2	3.2 to 12.7		5 or 6
	Over 1/2	Over 12.7		6 or 8
Oxygen cutting	Under 1	Under 25		3 or 4
	1 to 6	25 to 150		4 or 5
	Over 6	Over 150		5 or 6

⁽¹⁾ As a rule of thumb, start with a shade that is too dark, then go to a lighter shade which gives sufficient view of the weld zone without going below the minimum. In oxyfuel gas welding or cutting where the torch produces a high yellow light, it is desirable to use a filter lens that absorbs the yellow or sodium line the visible light of the (spectrum) operation.

⁽²⁾ These values apply where the actual arc is clearly seen. Experience has shown that lighter filters may be used when the arc is hidden by the workpiece.

DENMARK

Main office

MIGATRONIC A/S

Aggersundvej 33, DK-9690 Fjerritslev, Denmark
Tel. +45 96 500 600, www.migatron.com

MIGATRONIC AUTOMATION A/S

Knøsgårdvej 112, DK-9440 Aabybro, Denmark
Tel. +45 96 96 27 00, www.migatron-automation.com

MIGATRONIC EUROPE:

Great Britain

MIGATRONIC WELDING EQUIPMENT LTD

1 Sarah Court, Armthorpe
GB-Doncaster DN3 3FD, Great Britain
Tel. +44 2080730100, www.migatron.com

Czech Republic

MIGATRONIC CZ a.s.

Tolstého 451, CZ-415 03 Teplice 3, Czech Republic
Tel. +420 411 135 600, www.migatron.com

France

MIGATRONIC EQUIPEMENT DE SOUDURE S.A.R.L.

Parc Avenir II, 313 Rue Marcel Merieux
FR-69530 Brignais, France
Tel. +33 04 78 50 65 11, www.migatron.com

Sweden

MIGATRONIC SVETSMASKINER AB

Nääs Fabriker, Box 5015, S-448 50 Tollerød, Sweden
Tel. +46 031 44 00 45, www.migatron.com

Italy

MIGATRONIC s.r.l. IMPIANTI PER SALDATURA

Via Dei Quadri 40, IT-20871 Vimercate (MB), Italy
Tel. +39 039 9278093, www.migatron.com

Germany

MIGATRONIC SCHWEISSMASCHINEN GMBH

Sandusweg 12, D-35435 Wettenberg-Launsbach, Germany
Tel. +49 0641/98284-0, www.migatron.com

Norway

MIGATRONIC NORGE AS

Industriveien 6, N-3300 Hokksund, Norway
Tel. +47 32 25 69 00, www.migatron.com

MIGATRONIC ASIA:

India

MIGATRONIC INDIA PRIVATE LTD.

No.22 & 39/20H Sowri Street,
IN-Alandur, Chennai – 600 016, India
Tel. +91 44 2233 0074 www.migatron.com