

PRO-152T | HEAVY DUTY TAPPING AND DRILLING MACHINE



The PRO-152T drilling machine is designed for large hole making and very big tapping applications.

Powerful variable speed motor enables milling capacity up to 150 mm (5-7/8") and drilling capacity up to 47 mm (1-7/8").

Machine's forward & reverse work modes allow thread cutting up to M42 with Promotech's new tapping system.

Four speed gearbox with continuous speed adjustment allows to set the optimal speed depending on diameter, steel grade or tool quality.













Intelligent speed control system maintains constant motor speed regardless of changing loads.

Innovative 360-degree LED indicator facilitates proper machine operation and increases work safety.

Features and benefits:













- powerful motor with heavy duty 4-speed gearbox
- Electronic Speed Stabilization System (ESSS) maintains stable speed regardless of load changes
- tapping of through and blind holes
- milling with TCT or HSS cutters or drilling
- electronic clutch
- both overload and overheat protection
- rigid design extends tool life
- tilt sensor stops the motor if machine breaks away
- 360-degree visual monitoring system indicates current condition of the drill and gives safety and diagnostic information e.g. worn brushes
- innovative smart magnet with reduced weight
- Magnetic Field Shape Control (MFSC) provides maximum holding power on thin materials
- Energy Saving Base(ESB) uses only 50% of its power when motor is not running
- Semi-automatic gib adjustment enables simple, fast, correct and repeatable slide backlash settings without any expert knowledge or experience
- intuitive control panel at top of the drill
- large coolant container



												
Core drill max 150 mm (5-7/8")	Twist drill max 47 mm (1-7/8")	Spindle MT4	Depth of cut 100 mm (4")	Stroke 260 mm (10")	Speed 55-85 rpm 100-150 rpm 200-300 rpm 350-520 rpm	Power 2300 W	Weight 31 kg (68 lbs)	Thread cutting M42 (1-5/8")	Worn brushes indicator	Thermal /overheat protection	Overload protection	Magnet detachment safeguard

360-degree Visual Monitoring System – VMS



 CONDITION OF THE DRILL		Ready to Operate (Solid Green)
		Normal Operation (Solid White)
		Motor Overheat (Solid Red)
		Emergency Stop/Overload Condition (Solid Blue)
		Emergency Stop/Low Adhesion (Solid Violet)
 SAFETY INFORMATION		Inadequate Adhesion (Flashing Green)
		Near Overload (Flashing Blue)
 DIAGNOSTIC INFORMATION		Emergency Stop/Voltage Drop (Red Flashes to Blue)
		Emergency Stop/Worn Brushes (Red Flashes to Green)



Milling capacity up to 150 mm (5-7/8")



Drilling capacity up to 47 mm (1-7/8")
Max stroke up to 260 mm (10")



Counterclockwise (CCW) rotation
User-friendly control of tapping tool retract

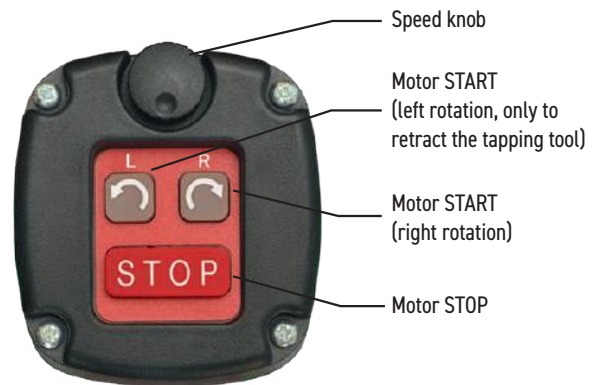

Intuitive control panel at top of the drill

■ Promotech introduces quick change tapping system including:



- TC – Tapping chucks with securing nut
- TA – Tapping Adapters for through holes
- TASC – Tapping Adapters Safety Clutch for blind holes
- RA – Reduction Adapters

PRO-152T - Available tapping configurations

Tapping tool	Tapping chucks		
	MT4-31	MT4-48	MT4-60
M8	TA-1 or TASC-1 along with optional RA 2/1	TA-1 or TASC-1 along with optional RA 3/1	
M10			
M12			
M8	TA-2 or TASC-2	TA-2 or TASC-2 along with optional RA 3/2	TA-2 or TASC-2 along with optional RA 4/2
M10			
M12			
M14			
M16			
M18			
M20		TA-3 or TASC-3	TA-3 or TASC-3 along with optional RA 4/3
M14			
M16			
M18			
M20			
M22, M24			
M27		TA-4 or TASC-4	
M30			
M33			
M36		TA-4	
M42			

Standard tapping configuration

Optional tapping configuration

■ Promotech quick change tapping system accessories suitable for PRO-152T drilling machine:

TC – Tapping chucks with securing nuts

Product Code	Type	Description
OPR-0584-09-00-00-1	MT4-31	Tapping chuck MT4 x 31 mm
OPR-0584-04-00-00-1	MT4-48	Tapping chuck MT4 x 48 mm
OPR-0584-07-00-00-1	MT4-60	Tapping chuck MT4 x 60 mm



Tapping chuck equipped with securing nut protects tapping tool against pull out



Shipping set of tapping chuck incl. HD-CUT OIL1

Through hole tapping up to M42



Tapping chuck - TC

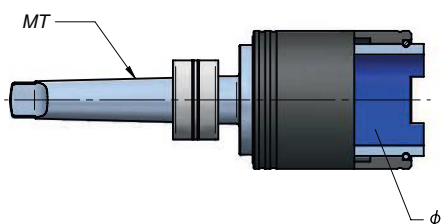

Tapping adapter - TA

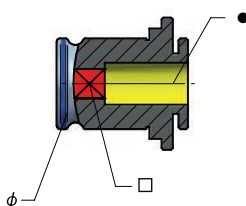

Tapping tool

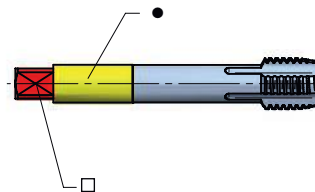

TA - Tapping Adapters

Product Code	Type	Description	∅ [mm]	Tap size	● [mm]	□ [mm]
WKL-000069	TA-1	Tapping Adapter 19 mm x M8	19	M8	8	6,2
WKL-000070	TA-1	Tapping Adapter 19 mm x M10	19	M10	10	8
WKL-000071	TA-1	Tapping Adapter 19 mm x M12	19	M12	9	7
WKL-000072	TA-2	Tapping Adapter 31 mm x M8	31	M8	8	6,2
WKL-000073	TA-2	Tapping Adapter 31 mm x M10	31	M10	10	8
WKL-000074	TA-2	Tapping Adapter 31 mm x M12	31	M12	9	7
WKL-000075	TA-2	Tapping Adapter 31 mm x M14	31	M14	11	9
WKL-000076	TA-2	Tapping Adapter 31 mm x M16	31	M16	12	9
WKL-000077	TA-2	Tapping Adapter 31 mm x M18	31	M18	14	11
WKL-000078	TA-2	Tapping Adapter 31 mm x M20	31	M20	16	12
WKL-000079	TA-3	Tapping Adapter 48 mm x M14	48	M14	11	9
WKL-000080	TA-3	Tapping Adapter 48 mm x M16	48	M16	12	9
WKL-000081	TA-3	Tapping Adapter 48 mm x M18	48	M18	14	11
WKL-000082	TA-3	Tapping Adapter 48 mm x M20	48	M20	16	12
WKL-000083	TA-3	Tapping Adapter 48 mm x M22/M24	48	M22, M24	18	14,5
WKL-000084	TA-3	Tapping Adapter 48 mm x M27	48	M27	20	16
WKL-000085	TA-3	Tapping Adapter 48 mm x M30	48	M30	22	18
WKL-000086	TA-4	Tapping Adapter 60 mm x M24	60	M24	18	14,5
WKL-000087	TA-4	Tapping Adapter 60 mm x M27	60	M27	20	16
WKL-000088	TA-4	Tapping Adapter 60 mm x M30	60	M30	22	18
WKL-000089	TA-4	Tapping Adapter 60 mm x M33	60	M33	25	20
WKL-000090	TA-4	Tapping Adapter 60 mm x M36	60	M36	28	22
WKL-000091	TA-4	Tapping Adapter 60 mm x M42	60	M42	32	24

Blind hole tapping up to M33



Tapping chuck - TC

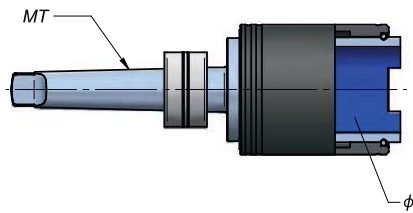

Tapping adapter - TASC

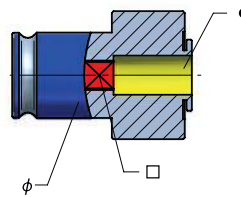

Tapping tool

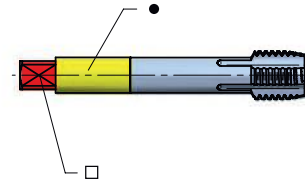

TASC - Tapping Adapters Safety Clutch

Product Code	Type	Description	∅ [mm]	Tap size	● [mm]	□ [mm]
WKL-000095	TASC-1	Tapping Adapter with Safety Clutch 19 mm x M8	19	M8	8	6,2
WKL-000098	TASC-1	Tapping Adapter with Safety Clutch 19 mm x M10	19	M10	10	8
WKL-000099	TASC-1	Tapping Adapter with Safety Clutch 19 mm x M12	19	M12	9	7
WKL-000100	TASC-2	Tapping Adapter with Safety Clutch 31 mm x M8	31	M8	8	6,2
WKL-000101	TASC-2	Tapping Adapter with Safety Clutch 31 mm x M10	31	M10	10	8
WKL-000102	TASC-2	Tapping Adapter with Safety Clutch 31 mm x M12	31	M12	9	7
WKL-000103	TASC-2	Tapping Adapter with Safety Clutch 31 mm x M14	31	M14	11	9
WKL-000104	TASC-2	Tapping Adapter with Safety Clutch 31 mm x M16	31	M16	12	9
WKL-000105	TASC-2	Tapping Adapter with Safety Clutch 31 mm x M18	31	M18	14	11
WKL-000106	TASC-2	Tapping Adapter with Safety Clutch 31 mm x M20	31	M20	16	12
WKL-000107	TASC-3	Tapping Adapter with Safety Clutch 48 mm x M14	48	M14	11	9
WKL-000108	TASC-3	Tapping Adapter with Safety Clutch 48 mm x M16	48	M16	12	9
WKL-000109	TASC-3	Tapping Adapter with Safety Clutch 48 mm x M18	48	M18	14	11
WKL-000110	TASC-3	Tapping Adapter with Safety Clutch 48 mm x M20	48	M20	16	12
WKL-000111	TASC-3	Tapping Adapter with Safety Clutch 48 mm x M22/M24	48	M22, M24	18	14,5
WKL-000112	TASC-3	Tapping Adapter with Safety Clutch 48 mm x M27	48	M27	20	16
WKL-000113	TASC-3	Tapping Adapter with Safety Clutch 48 mm x M30	48	M30	22	18
WKL-000114	TASC-4	Tapping Adapter with Safety Clutch 60 mm x M24	60	M24	18	14,5
WKL-000115	TASC-4	Tapping Adapter with Safety Clutch 60 mm x M27	60	M27	20	16
WKL-000116	TASC-4	Tapping Adapter with Safety Clutch 60 mm x M30	60	M30	22	18
WKL-000117	TASC-4	Tapping Adapter with Safety Clutch 60 mm x M33	60	M33	25	20

RA - Reduction Adapters

Product Code	Type	Description
RDC-000008	RA 2/1	Reduction Adapter 2/1 (31 mm / 19 mm)
RDC-000009	RA 3/1	Reduction Adapter 3/1 (48 mm / 19 mm)
RDC-000010	RA 3/2	Reduction Adapter 3/2 (48 mm / 31 mm)
RDC-000011	RA 4/2	Reduction Adapter 4/2 (60 mm / 31 mm)
RDC-000012	RA 4/3	Reduction Adapter 4/3 (60 mm / 48 mm)



PRO-152T TECHNICAL SPECIFICATION	
Motor Speeds (under load)	55-85 rpm (gear I) 100-150 rpm (gear II) 200-300 rpm (gear III) 350-520 rpm (gear IV)
Power	2300 W
Weight	31 kg (68 lbs)
Max milling capacity	150 mm (5-7/8")*
Max drilling capacity	47 mm (1-7/8")
Max Tap size	M42 (1-5/8")
Stroke	260 mm (10")
Max depth of cut	100 mm (4")
Voltage	1~ 220-240 V, 50-60 Hz 1~ 110-120 V, 50-60 Hz
Overload protection	yes
Overheat protection	yes
Continuous Speed Adjustment	yes
ESSS (Electronic Speed Stabilization System)	yes
Semi-automatic gib adjustment	yes
MFSC (Magnetic Field Shape Control)	yes
ESB - Energy Saving Base	yes
Magnet detachment safeguard	yes
Magnetic clamping force (surface with the thickness of 25 mm and roughness Ra = 1.25)	2550 kgf (25 000 N)
Magnet Base Dimensions	105 mm × 315 mm × 50 mm 4-1/8" × 12-3/8" × 2"
Min. Workpiece Thickness	10 mm (3/8")
Spindle	MT4
Tool holder	19 mm (3/4") or 32 mm (1-1/4") Weldon
Product Code 220-240 V, 50-60 Hz	WRT-0583-10-20-01-0
Product Code 110-120 V, 50-60 Hz	WRT-0583-10-10-01-0

* If more than 60 mm (2.36"), use an MT4 arbor with 32 mm Weldon tool holder (UCW-583-13-00-00-0).

Dimensions:

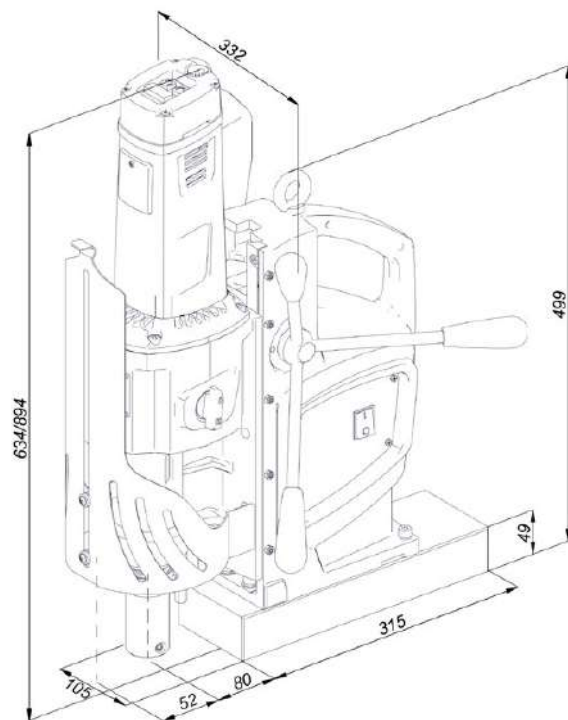

Standard shipping set:

- Drilling machine
- Metal box
- Handle (3 pcs)
- MT4 arbor with 19 mm (3/4") Weldon tool holder
- Safety strap
- Cooling system
- Protective spring for cooling hose
- MT4 drift
- 6 mm hex wrench
- 5 mm hex wrench with a handle
- 2.5 mm hex wrench
- 8 mm combination wrench
- Tool can
- Locking connector (only in 115 V version)
- Operator's Manual



Max depth of cut up to 100 mm (4")

More optional accessories:



Arbor MT4 x 32 mm Weldon
for drilling diameter over 60 mm (2.3")
product code: UCW-0583-13-00-00-0



Pressure cooling system
capacity of 2 liters
product code: UKL-0440-16-00-00-0

